

DH-PFA123

Water-proof Junction Box



Features

- Neat & Integrated design
- Material: Aluminum
- IP66 junction box

Technical Specifications

Model	DH-PFA123
General	
Material	Aluminum
Dimension (W x H x D)	134.0mmx133.5mmx52.0mm (5.28"x5.25"x2.05")
Pipe thread	G3/4"
Weight	0.54kg(1.19lb)
Load bearing	3.0kg(6.61lb)
Color	White
Protection	IP66
Operating temperature	-40°C ~60°C(-40°F ~140°F)
Humidity	0~90% RH
Applicable model	Please see "Accessory Selection"

Order Information

Type	Part Number	Description
Camera mount	DH-PFA123	Water-proof junction box
	PFA123	Water-proof junction box

Dimensions (mm/inch)

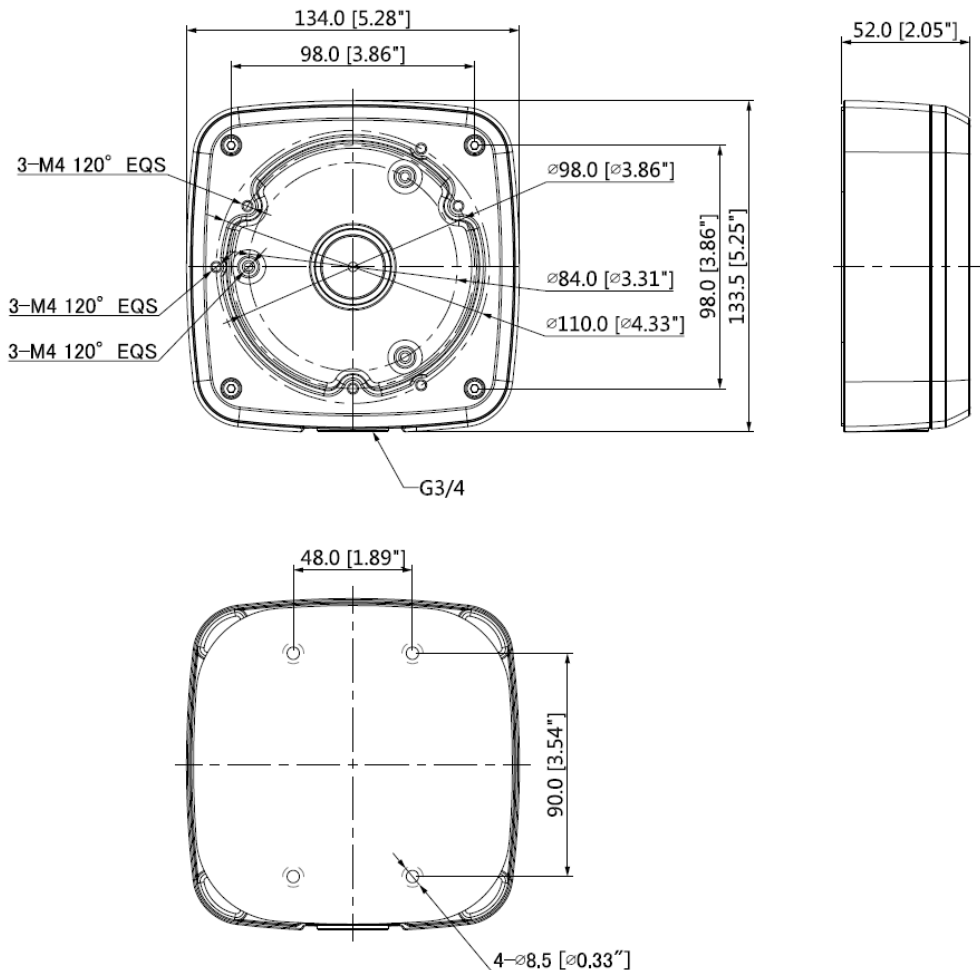

Application

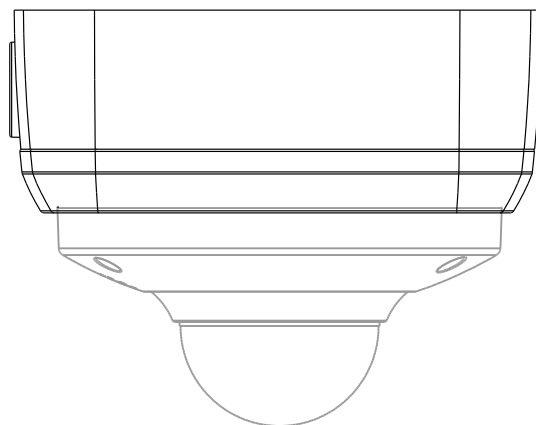

Package Information

- Water-proof junction box *1
- M4x10 screw *3
- ST4.2x25 screw *4
- Plastic Anchor: 4
- S3.0 wrench *1