

DH-CA-F481E

700TVL Day/Night Camera



Features

- 1/3" SONY EXview HAD CCD II & Effio DSP
- High resolution of 700TVL
- DWDR, Day/Night(ICR), Auto iris, AWB, AGC, BLC, MD, Privacy Masking, Picture Adjustment
- OSD, AC24V/DC12V

DH-CA-F481E

Technical Specifications





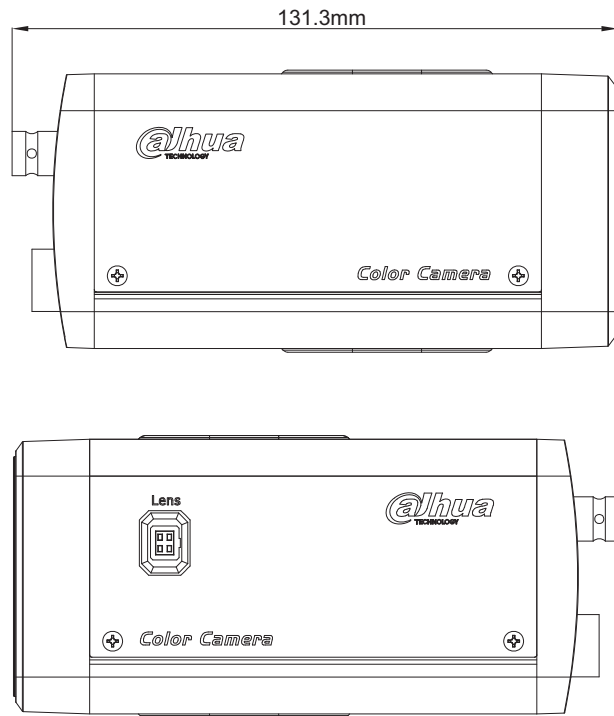
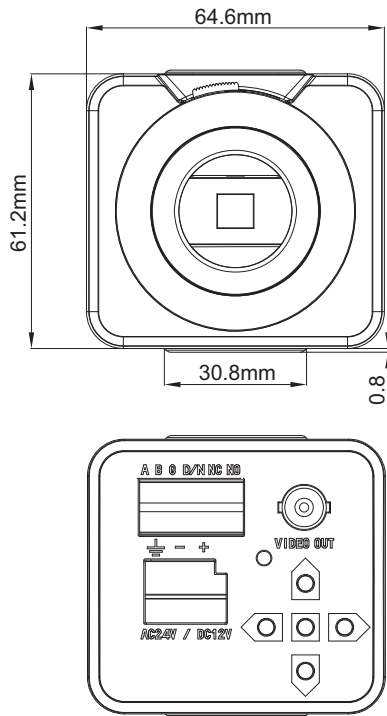

Model	DH-CA-F481EP-A	DH-CA-F481EN-A
Camera		
Image Sensor	1/3" EXview HAD CCD II	
Effective Pixels	976(H)×582(V), 570K pixels	976(H)×494(V), 480K pixels
Horizontal Resolution	700TVL	
Electronic Shutter	1/50s~1/100,000s	1/60s~1/100,000s
Synchronization	Internal	
Min. Illumination	Color: 0.001Lux@F1.2	
	B/W: 0.0001Lux@F1.2	
S/N Ratio	> 65dB	
Video Output	1Vp-p Composite Output (75Ω/BNC)	
Camera Features		
OSD	English, Chinese, French, German, Russian, Spanish, Portuguese, Japanese	
Day/Night	Auto (ICR) / Color / B/W	
Backlight Compensation	BLC / HLC / DWDR	
White Balance	Auto Trace WB1 / Auto Trace WB2 / Manual / Auto	
Gain Control	Auto / Manual	
Noise Reduction	2D	
Privacy Masking	Up to 4 areas	
Picture Adjustment	Mirror / Brightness / Contrast / Sharpness / Hue / Gain	
Lens		
Lens Type	Manual / Auto iris	
Mount Type	C/CS	
Auxiliary Interface		
RS485	1 port	
General		
Power Supply	AC24V±10% / DC12V±10%	
Power Consumption	Max 6W	
Working Environment	-30°C~+60°C / 20%~80%RH	
Dimensions(W×D×H)	64.6mm×131.3mm×61.2mm	
Weight	0.5kg	

DH-CA-F481E

Dimensions (mm)



Accessories (optional)

				
PFB120W	PFB121W	PFA121	PFA150	PFA152
				
PFH600N	PFH610N			

Dahua Technology Co., Ltd.

1187 BinAn Road, Binjiang District, Hangzhou, China

Tel: +86-571-87688883

Fax: +86-571-87688815

Email:overseas@dahuatech.com

www.dahuatech.com

*Design and specifications are subject to change without notice.

© 2013 Dahua Technology Co., Ltd.